

PR Series

Cylindrical type proximity sensor

■ Features

- Improved the noise resistance with dedicated IC (DC 3-wire)
- Reverse power polarity, surge, overcurrent protection
(Except for PR08 Series.)
- Long life cycle and reliable simple operation
- Red LED status indication
- IP67 rated waterproof structure (IEC standard)
- Replacer for micro switches and limit switches



⚠ Please read "Caution for your safety" in operation manual before using.



■ Specifications

● DC 2-wire type

| Model | PRT08-1.5DO PRT08-1.5DC | PRT08-2DO PRT08-2DC | PRT12-2DO PRT12-2DC | PRT12-4DO PRT12-4DC | PRT18-5DO PRT18-5DC | PRT18-8DO PRT18-8DC | PRT30-10DO PRT30-10DC | PRT30-15DO PRT30-15DC |
|----------------------------------|---|------------------------|------------------------|------------------------|------------------------|------------------------|--------------------------|--------------------------|
| Sensing distance | 1.5mm ±10% | 2mm ±10% | 2mm ±10% | 4mm ±10% | 5mm ±10% | 8mm ±10% | 10mm ±10% | 15mm ±10% |
| Hysteresis | Max. 10% of sensing distance | | | | | | | |
| Standard sensing target | 8×8×1mm (Iron) | | 12×12×1mm (Iron) | | 18×18×1mm (Iron) | 25×25×1mm (Iron) | 30×30×1mm (Iron) | 45×45×1mm (Iron) |
| Setting distance | 0 ~ 1.05mm | 0 ~ 1.4mm | 0 ~ 1.4mm | 0 ~ 2.8mm | 0 ~ 3.5mm | 0 ~ 5.6mm | 0 ~ 7mm | 0 ~ 10.5mm |
| Power supply (Operation voltage) | 24VDC (15-30VDC) | | | | | | | |
| Leakage current | Max. 0.6mA | | | | | | | |
| Response frequency(*1) | 1.5kHz | 1kHz | 1.5kHz | 500Hz | | 350Hz | 400Hz | 200Hz |
| Residual voltage | Max. 7V | | | | | | | |
| Affection by Temp. | ±10% Max. for sensing distance at +20°C within temperature range of -25 ~ +70°C | | | | | | | |
| Control output | 2 ~ 100mA | | | | | | | |
| Insulation resistance | Min. 50MΩ (at 500VDC mega) | | | | | | | |
| Dielectric strength | 1500VAC 50/60Hz for 1minute | | | | | | | |
| Vibration | 1mm amplitude at frequency of 10 ~ 55Hz in each of X, Y, Z directions for 2 hours | | | | | | | |
| Shock | 500m/s ² (50G) in X, Y, Z direction for 3 times | | | | | | | |
| Indicator | Operation indicator (Red LED) | | | | | | | |
| Ambient temperature | -25 ~ +70°C (at non-freezing status) | | | | | | | |
| Storage temperature | -30 ~ +80°C (at non-freezing status) | | | | | | | |
| Ambient humidity | 35 ~ 95%RH | | | | | | | |
| Protection circuit | Surge, Overcurrent protection circuit | | | | | | | |
| Protection | IP67 (IEC standard) | | | | | | | |
| Cable spec. | φ 4×2P, 2m | | | | φ 5×2P, 2m | | | |
| Approval | CE | | | | | | | |
| Unit weight | Approx.36g | Approx.36g | Approx.63g | Approx.63g | Approx.122g | Approx.122g | Approx.181g | Approx.181g |

*(*1) The response frequency is the average value. The standard sensing target is used and the width is set as 2 times of the standard sensing target, 1/2 of the sensing distance for the distance.

Cylindrical Type Proximity Sensor

●DC 3-wire type

| | | | | | | | | |
|----------------------------------|--|-------------|-----------------------------------|-----------------------------------|-------------------------------------|-------------------------------------|-------------------------------------|-------------------------------------|
| Model | PR08-1.5DN | PR08-2DN | PR12-2DN | PR12-4DN | PR18-5DN | PR18-8DN | PR30-10DN | PR30-15DN |
| | PR08-1.5DP | PR08-2DP | PR12-2DP | PR12-4DP | PR18-5DP | PR18-8DP | PR30-10DP | PR30-15DP |
| | PR08-1.5DN2 | PR08-2DN2 | PR12-2DN2 | PR12-4DN2 | PR18-5DN2 | PR18-8DN2 | PR30-10DN2 | PR30-15DN2 |
| | PR08-1.5DP2 | PR08-2DP2 | PR12-2DP2 | PR12-4DP2 | PR18-5DP2 | PR18-8DP2 | PR30-10DP2 | PR30-15DP2 |
| | PRL08-1.5DN | PRL08-2DN | PRS12-2DN | PRS12-4DN | PRL18-5DN | PRL18-8DN | PRL30-10DN | PRL30-15DN |
| | PRL08-1.5DP | PRL08-2DP | PRS12-2DP | PRS12-4DP | PRL18-5DP | PRL18-8DP | PRL30-10DP | PRL30-15DP |
| | PRL08-1.5DN2 | PRL08-2DN2 | PRS12-2DN2 | PRS12-4DN2 | PRL18-5DN2 | PRL18-8DN2 | PRL30-10DN2 | PRL30-15DN2 |
| | PRL08-1.5DP2 | PRL08-2DP2 | PRS12-2DN2 | PRS12-4DP2 | PRL18-5DP2 | PRL18-8DP2 | PRL30-10DP2 | PRL30-15DP2 |
| Sensing distance | 1.5mm ±10% | 2mm ±10% | 2mm ±10% | 4mm ±10% | 5mm ±10% | 8mm ±10% | 10mm ±10% | 15mm ±10% |
| Hysteresis | Max. 10% of sensing distance | | | | | | | |
| Standard sensing target | 8×8×1mm (Iron) | | 12×12×1mm (Iron) | | 18×18×1mm (Iron) | 25×25×1mm (Iron) | 30×30×1mm (Iron) | 45×45×1mm (Iron) |
| Setting distance | 0 ~ 1.05mm | 0 ~ 1.4mm | 0 ~ 1.4mm | 0 ~ 2.8mm | 0 ~ 3.5mm | 0 ~ 5.6mm | 0 ~ 7mm | 0 ~ 10.5mm |
| Power supply (Operation voltage) | 12-24VDC (10-30VDC) | | | | | | | |
| Leakage current | Max. 10mA | | | | | | | |
| Response frequency(*1) | 1.5kHz | 1kHz | 1.5kHz | 500Hz | | 350Hz | 400Hz | 200Hz |
| Residual voltage | Max. 1.5V | | | | | | | |
| Affection by Temp. | ±10% Max. for sensing distance at +20°C within temperature range of -25 ~ +70°C, PR08 Series:Max. ±20% | | | | | | | |
| Control output | 200mA | | | | | | | |
| Insulation resistance | Min. 50MΩ (at 500VDC) | | | | | | | |
| Dielectric strength | 1500VAC 50/60Hz for 1minute | | | | | | | |
| Vibration | 1mm amplitude at frequency of 10 ~ 55Hz in each of X, Y, Z directions for 2 hours | | | | | | | |
| Shock | 500m/s ² (50G) in X, Y, Z direction for 3 times | | | | | | | |
| Indicator | Operation indicator (Red LED) | | | | | | | |
| Ambient temperature | -25 ~ +70°C (at non-freezing status) | | | | | | | |
| Storage temperature | -30 ~ +80°C (at non-freezing status) | | | | | | | |
| Ambient humidity | 35 ~ 95%RH | | | | | | | |
| Protection circuit | Surge, Reverse power polarity, Overcurrent protection circuit | | | | | | | |
| Protection | IP67 (IEC standard) | | | | | | | |
| Cable spec. | φ4×3P, 2m | | | | φ5×3P, 2m | | | |
| Approval | CE | | | | | | | |
| Unit weight | Approx. 36g | Approx. 36g | PR:Approx. 70g PRS:Approx. 68g | PR:Approx. 70g PRS:Approx. 68g | PR:Approx. 119g PRL:Approx. 150g | PR:Approx. 118g PRL:Approx. 150g | PR:Approx. 184g PRL:Approx. 222g | PR:Approx. 181g PRL:Approx. 227g |

*(*1) The response frequency is the average value. The standard sensing target is used and the width is set as 2 times of the standard sensing target, 1/2 of the sensing distance for the distance.

●AC 2-wire type

| | | | | | | |
|----------------------------------|---|-------------|---------------------------------------|---------------------------------------|---------------------------------------|---------------------------------------|
| Model | PR12-2AO | PR12-4AO | PR18-5AO | PR18-8AO | PR30-10AO | PR30-15AO |
| | PR12-2AC | PR12-4AC | PR18-5AC | PR18-8AC | PR30-10AC | PR30-15AC |
| | | | PRL18-5AO | PRL18-8AO | PRL30-10AO | PRL30-15AO |
| | | | PRL18-5AC | PRL18-8AC | PRL30-10AC | PRL30-15AC |
| Sensing distance | 2mm ±10% | 4mm ±10% | 5mm ±10% | 8mm ±10% | 10mm ±10% | 15mm ±10% |
| Hysteresis | Max. 10% of sensing distance | | | | | |
| Standard sensing target | 12×12×1mm (Iron) | | 18×18×1mm (Iron) | 25×25×1mm (Iron) | 30×30×1mm (Iron) | 45×45×1mm (Iron) |
| Setting distance | 0 ~ 1.4mm | 0 ~ 2.8mm | 0 ~ 3.5mm | 0 ~ 5.6mm | 0 ~ 7mm | 0 ~ 10.5mm |
| Power supply (Operation voltage) | 100-240VAC (85-264VAC) | | | | | |
| Leakage current | Max. 2.5mA | | | | | |
| Response frequency(*1) | 20Hz | | | | | |
| Residual voltage | Max. 10V | | | | | |
| Affection by Temp. | ±10% Max. for sensing distance at +20°C within temperature range of -25 ~ +70°C | | | | | |
| Control output | 5 ~ 150mA | | | 5 ~ 200mA | | |
| Insulation resistance | Min. 50MΩ (at 500VDC) | | | | | |
| Dielectric strength | 2500VAC 50/60Hz for 1minute | | | | | |
| Vibration | 1mm amplitude at frequency of 10 ~ 55Hz in each of X, Y, Z directions for 2 hours | | | | | |
| Shock | 500m/s ² (50G) in X, Y, Z direction for 3 times | | | | | |
| Indicator | Operation indicator (Red LED) | | | | | |
| Ambient temperature | -25 ~ +70°C (at non-freezing status) | | | | | |
| Storage temperature | -30 ~ +80°C (at non-freezing status) | | | | | |
| Ambient humidity | 35 ~ 95%RH | | | | | |
| Protection circuit | Surge protection circuit | | | | | |
| Protection | IP67 (IEC standard) | | | | | |
| Cable spec. | φ4×2P, 2m | | | φ5×2P, 2m | | |
| Approval | CE | | | | | |
| Unit weight | Approx. 66g | Approx. 66g | PR : Appox. 130g PRL : Appox. 150g | PR : Appox. 130g PRL : Appox. 150g | PR : Appox. 185g PRL : Appox. 224g | PR : Appox. 117g PRL : Appox. 222g |

*(*1) The response frequency is the average value. The standard sensing target is used and the width is set as 2 times of the standard sensing target, 1/2 of the sensing distance for the distance.

- (A) Counter
- (B) Timer
- (C) Temp. controller
- (D) Power controller
- (E) Panel meter
- (F) Tacho/Speed/Pulse meter
- (G) Display unit
- (H) Sensor controller
- (I) Switching power supply
- (J) Proximity sensor
- (K) Photo electric sensor
- (L) Pressure sensor
- (M) Rotary encoder
- (N) Stepping motor & Driver & Controller
- (O) Graphic panel
- (P) Production stoppage models & replacement

PR Series

■ Dimensions

(Unit:mm)

●PR(T)08-1.5D□



●PR(T)08-2D□



●PR(T)18-5D□



●PR(T)18-8D□



●PRS12-2D□



●PRS12-4D□

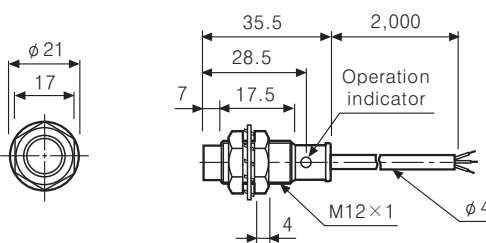

●PR(T)30-10D□



●PR(T)30-15D□



●PR(T)12-2D□



●PR(T)12-4D□

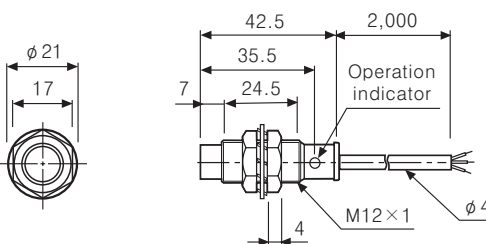

●PRL08-1.5D□



●PRL08-2D□



Cylindrical Type Proximity Sensor

Dimensions

(Unit:mm)

●PRL12-4D□



●PR12-2A□



●PR12-4A□



●PRL18-5D□



●PRL18-5A□

●PR18-5A□

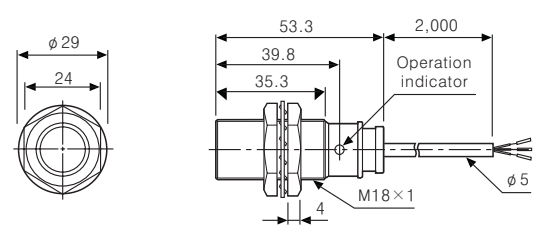

●PRL18-8D□



●PRL18-8A□

●PR18-8A□

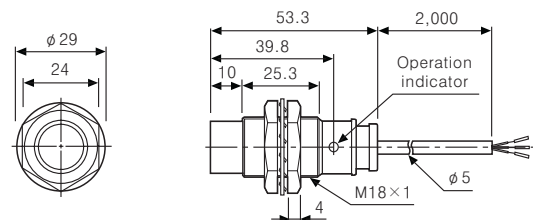

●PRL30-10D□



●PRL30-10A□

●PR30-10A□



●PRL30-15D□

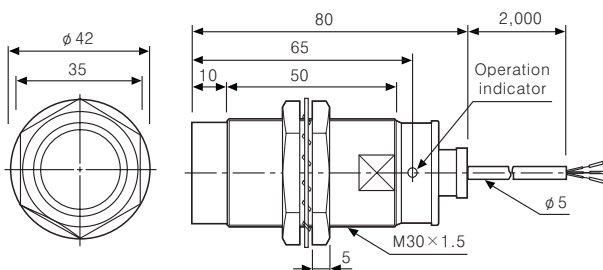

●PRL30-15A□

●PR30-15A□

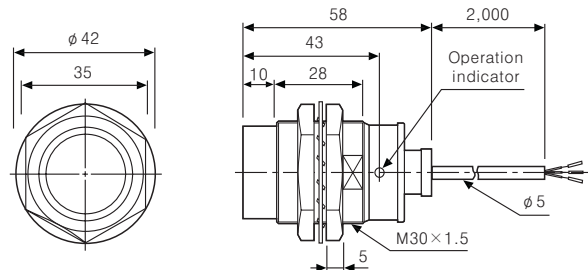

(A) Counter

(B) Timer

(C) Temp. controller

(D) Power controller

(E) Panel meter

(F) Tacho/Speed/Pulse meter

(G) Display unit

(H) Sensor controller

(I) Switching power supply

(J) Proximity sensor

(K) Photo electric sensor

(L) Pressure sensor

(M) Rotary encoder

(N) Stepping motor & Driver & Controller

(O) Graphic panel

(P) Production stoppage models & replacement

PR Series

Control output diagram

DC 2-wire type



DC 3-wire type



AC 2-wire type



Connections

DC 2-wire type



※The load can be connected to either wire.

DC 3-wire type

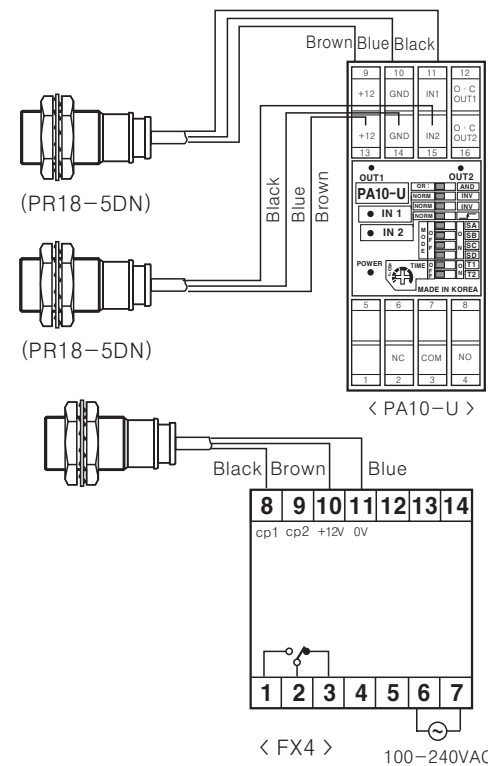

AC 2-wire type

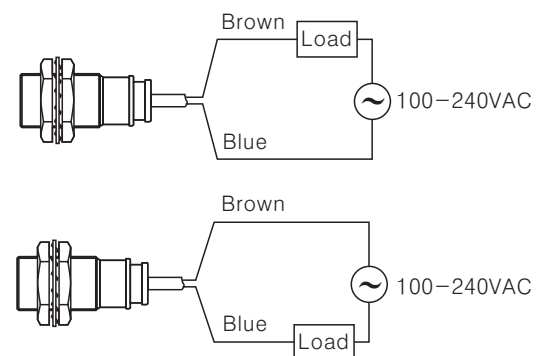

※The load can be connected to either wire.

Cylindrical Type Proximity Sensor

■ Proper usage

○ Load connections



When using DC or AC 2-wire type proximity sensor, the load must be connected, otherwise internal components may be damaged. And the load can be connected to either wire.

○ In case of the load current is small

● AC 2-wire type



It may cause return failure of load by residual voltage. If the load current is under 5mA, please make sure the residual voltage is less than the return voltage of the load by connecting a bleeder resistor in parallel with the load as shown in the diagram.

$$R = \frac{V_s}{I} \text{ (}\Omega\text{)} \quad P = \frac{V_s^2}{R} \text{ (W)}$$

[I: Action current of load, R: Bleeder resistance, P: Permissible power]

● DC 2-wire type



Please make the current on proximity sensor smaller than the return current of load by connecting a bleeder resistor in parallel. ※W value of Bleeder resistor should be bigger for proper heat dissipation.

$$R = \frac{V_s}{I_o - I_{off}} \text{ (}\Omega\text{)} \quad P = \frac{V_s^2}{R} \text{ (W)}$$

[Vs : Power supply, Io : Min. action current of proximity sensor
Ioff : Return current of load, P : Number of Bleeder resistance watt]

○ Mutual-interference & Influence by surrounding metals

When several proximity sensors are mounted closely, malfunction of sensor may be caused due to mutual interference. Therefore, be sure to provide a minimum distance between the two sensors, as below charts.

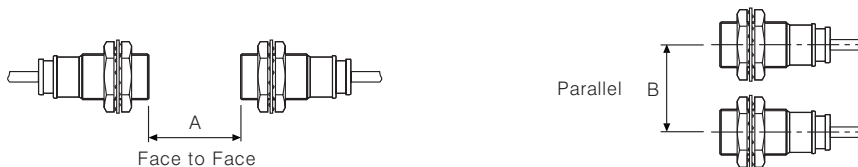

When sensors are mounted on metallic panel, it is required to protect the sensors from being affected by any metallic object except target. Therefore, be sure to provide a minimum distance as below chart.



(Unit:mm)

| Model | PR08-1.5D□ PRT08-1.5D□ | PR08-2D□ PRT08-2D□ | PR(T)12-2D□ PRS12-2D□ PR12-2A□ | PR(T)12-4D□ PRS12-4D□ PR12-4A□ | PR(T)18-5D□ PRL18-5D□ PR18-5A□ PRL18-5A□ | PR(T)18-8D□ PRL18-8D□ PR18-8A□ PRL18-8A□ | PR(T)30-10D□ PRL30-10D□ PR30-10A□ PRL30-10A□ | PR(T)30-15D□ PRL30-15D□ PR30-15A□ PRL30-15A□ |
|-------|---------------------------|-----------------------|--------------------------------------|--------------------------------------|---|---|---|---|
| A | 9 | 12 | 12 | 24 | 30 | 48 | 60 | 90 |
| B | 16 | 24 | 24 | 36 | 36 | 54 | 60 | 90 |
| l | 0 | 8 | 0 | 11 | 0 | 14 | 0 | 15 |
| φd | 8 | 24 | 12 | 36 | 18 | 54 | 30 | 90 |
| m | 4.5 | 6 | 6 | 12 | 15 | 24 | 30 | 54 |
| n | 12 | 24 | 18 | 36 | 27 | 54 | 45 | 90 |

(A) Counter

(B) Timer

(C) Temp. controller

(D) Power controller

(E) Panel meter

(F) Tacho/Speed/Pulse meter

(G) Display unit

(H) Sensor controller

(I) Switching power supply

(J) Proximity sensor

(K) Photo electric sensor

(L) Pressure sensor

(M) Rotary encoder

(N) Stepping motor & Driver & Controller

(O) Graphic panel

(P) Production stoppage models & replacement